

# LCM Specification

Preliminary specification

Final Specification

Project No. 项目编号	TFT-H080A2XGTHX3N40		
Customer 客户名称			
Module No. 客户型号			
Product type 产品内容	TFT LCD Module 1024 x 3RGB x 768 Dots 8.0" TFT LCD		
Signature by customer: 客户确认签章:			
<input type="checkbox"/> Trial production		<input type="checkbox"/> Mass production	
编 制	电子审核	结构审核	批 准
Y. L			

深圳市鑫洪泰电子科技有限公司

Shenzhen Hot Display Technology Co., Ltd

**1 Document revision history :**

DOCUMENT REVISION	DATE	DESCRIPTION	PREPARED BY	APPROVED BY
0	2020-06-14	First Release.	Y.L	
1	2020-12-10	Change the backlight	Y.L	

## 1. General Feature:

Item	Standard Value	Unit
Display Size	8.0"	--
Number of Pixels	1024(H)x3(RGB)*768(V)	--
Active Area	162.05(H) * 121.54(V)	mm
Outline Dimension	<b>174.50(H) × 135.70(V) × 3.00(D)</b>	mm
Viewing Direction	12 O'clock	-
Interface	LVDS 4L	-
Panel Driver IC	HX8282A+HX8695_B01	-
Panel Driver Condition	VCI=3.3V	V
Backlight	White LED	-
Touch Panel	Without Touch Panel	-
Cap Touch Driver IC	---	-
Cap Touch Driver Condition	---	V
Operation Temperature	-20~70	°C
Storage Temperature	-30~80	°C

## 2.Outline Dimensions

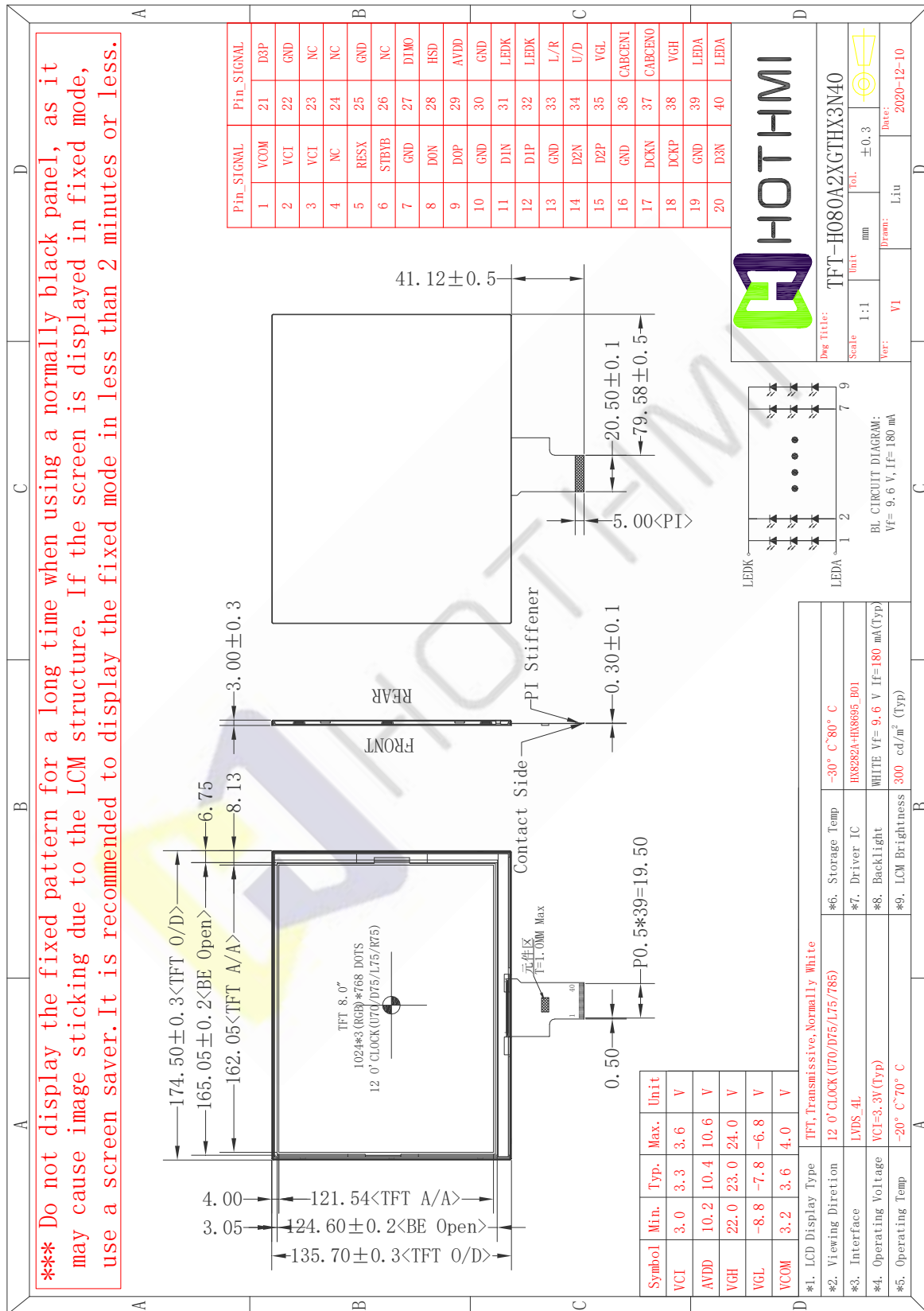

### 3. Pin Description

#### 3.1 Pin Description

Pin NO.	Symbol	Description
1	VCOM	TFT Common Electrode Voltage
2,3	VDD	Analog Power
4	NC	Disconnect pin
5	RESX	Global reset pin.Active low to enter Reset State. Suggest to connecting with an RC reset circuit for stability.
6	STBYB	Standby mode control. Normally pull High. When STB=H, all the functions are on. (Default pulls high). When STB=L, TCON and source driver are off and all output are High-z.
7	GND	Ground
8	D0N	Negative LVDS differential data inputs
9	D0P	Positive LVDS differential data inputs
10	GND	Ground
11	D1N	Negative LVDS differential data inputs
12	D1P	Positive LVDS differential data inputs
13	GND	Ground
14	D2N	Negative LVDS differential data inputs
15	D2P	Positive LVDS differential data inputs
16	GND	Ground
17	DCKN	Negative LVDS differential clock inputs
18	DCKP	Positive LVDS differential clock inputs
19	GND	Ground
20	D3N	Negative LVDS differential data inputs
21	D3P	Positive LVDS differential data inputs
22	GND	Ground
23-24	NC	Disconnect pin
25	GND	Ground
26	NC	Disconnect pin
27	DIMO	Backlight dimmer signal for external controller. DIMO=H, Logical control signal to turn on external backlight controller. DIMO=L, Turn off external backlight controller.
Continue to next page		

Pin NO.	Symbol	Description
28	HSD	6-bit/8-bit input select. HSD= "L", 8-bit; HSD= "H", 6-bit
29	AVDD	Power supply for analog circuits
30	GND	Ground
31,32	LED_K	LED Cathode
33	L/R	Source Right or Left sequence control. Normally pull high. SHLR = "L", shift left; SHLR = "H", shift right
34	U/D	Gate Up or Down scan control. Normally pull low. UPDN = "L", From top to bottom; UPDN = "H", From bottom to top.
35	VGL	Power supply for drive output Low
36	CABCEN1	CABC H/W enable pin. Normally pull low. When CABC_EN=" 00", CABC OFF. (Default mode) When CABC_EN=" 01", User interface Image.
37	CABCEN0	When CABC_EN=" 10", Still Picture. When CABC_EN=" 11", Moving Image.
38	VGH	Power supply for drive output High
39,40	LED_A	LED Anode
- END -		

### 3.2 Wiring Diagram

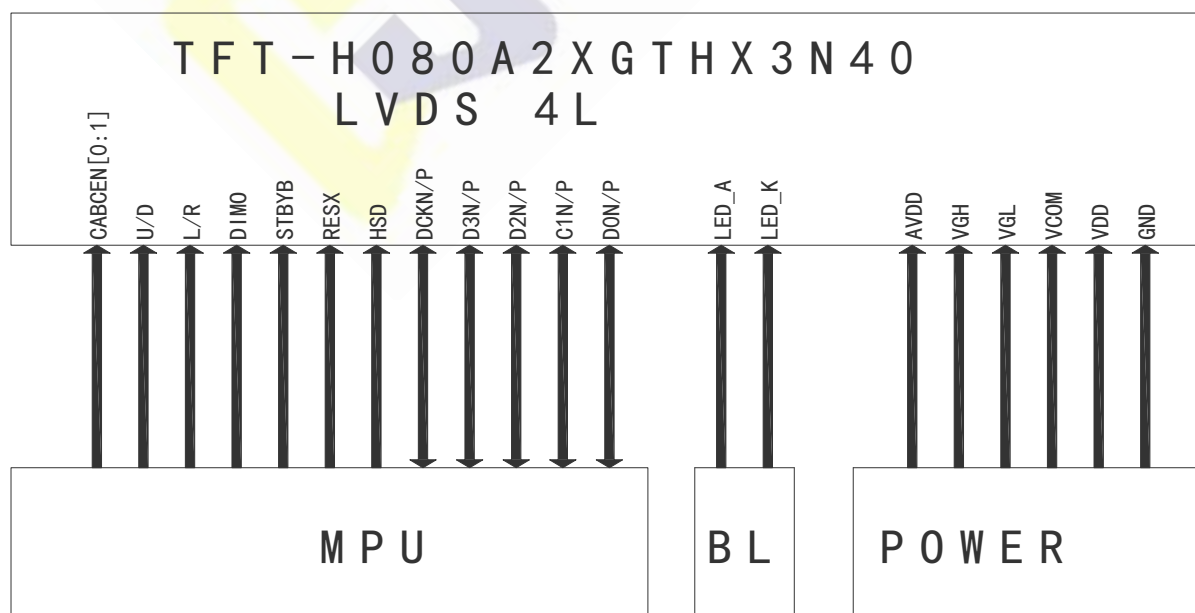

## 4. Electrical Characteristics

### 4-1 TFT LCD Module Operating Conditions

Item	Symbol	Condition	Min	Type	Max	Unit
Analog Power supply	VCI	-	3.0	3.3	3.6	V
Power For Analog Circuit	AVDD	-	10.2	10.4	10.6	V
TFT Gate on voltage	VGH	VGH-VGL	22.0	23.0	24.0	V
TFT Gate off voltage	VGL	≤40V	-8.8	-7.8	-6.8	V
TFT Common Electrode Voltage	VCOM	-	3.2	3.6	4.0	V

**Note: TFT VCOM PIN will generate large current. In order to keep the TFT VCOM output and TFT display stable, it is recommended to use VCOM BUFFER driver chip**

### 4-2 LED back light specification (per chip)

Item	Symbol	Condition	Min	Type	Max	Unit
Forward voltage	Vt	If=20mA	9.0	9.6	10.2	V
Forward current	Ipn	/1-chip	-	180	-	mA
Luminance(With LCD)	Lv	If=180mA	-	300	-	cd/m <sup>2</sup>
Luminous color	White					

## 5. OPTICAL SPECIFICATION

The test of Optical specifications shall be measured in a dark room (ambient luminance 1lux and temperature = 25 ± 2°C) with the equipment of Luminance meter system (Goniometer system and TOPCON BM-5) and test unit shall be located at an approximate distance 50cm from the LCD surface at a viewing angle of  $\theta$  and  $\Phi$  equal to 0°. The center of the measuring spot on the Display surface shall stay fixed. The backlight should be operating for 30 minutes prior to measurement.

Parameter		Symbol	Condition	Min.	Typ.	Max.	Unit	Remark
Viewing Angle Range	Horizontal	$\Theta$ L	CR>10	-	75	-	Deg.	Note 1
		$\Theta$ R		-	75	-	Deg.	
	Vertical	$\Theta$ U		-	70	-	Deg.	
		$\Theta$ D		-	75	-	Deg.	
Contrast ratio		CR	$\Theta = 0^\circ$	-	500	-		Note2
Color Gamutt (C light)		CG		-	50	-	%	
White Chromaticity		Wx	$\Theta = 0^\circ$	-0.03	0.293	+0.03		Note4 (Based on C Light)
		Wy			0.323			
Reproduction of color	Red	Rx			0.616			
		Ry			0.335			
	Green	Gx			0.284			
		Gy			0.538			
	Blue	Bx			0.148			
		By			0.141			
Response Time (Rising + Falling)		Tr+Tf	$\Theta = 0^\circ$ Ta= 25°C	-	20	30	ms	Note5
Transmittance		Tr		-	4.9		%	Note3

Note :

1. Viewing angle is the angle at which the contrast ratio is greater than 10. The viewing angles are determined for the horizontal or 3, 9 o' clock direction and the vertical or 6, 12 o' clock direction with respect to the optical axis which is normal to the LCD surface (see FIGURE 5).

2. Contrast measurements shall be made at viewing angle of  $\Theta = 0$  and at the center of the LCD surface. Luminance shall be measured with all pixels in the view field set first to white, then to the dark (black) state . (see FIGURE 5) Luminance Contrast Ratio (CR) is defined mathematically.

CR =Luminance when displaying a white raster / Luminance when displaying a black raster

3. Transmittance is the Value with Polarizer.



4. The color chromaticity coordinates specified in the above table shall be calculated from the spectral data measured with all pixels first in red, green, blue and white. Measurements shall be made at the center of the panel.

5. The electro-optical response time measurements shall be made as FIGURE 6 by switching the “data” input signal ON and OFF. The times needed for the luminance to change from 10% to 90% is  $T_r$ , and 90% to 10% is  $T_d$ .

Figure 4. The Definition of  $V_{th}$  &  $V_{sat}$

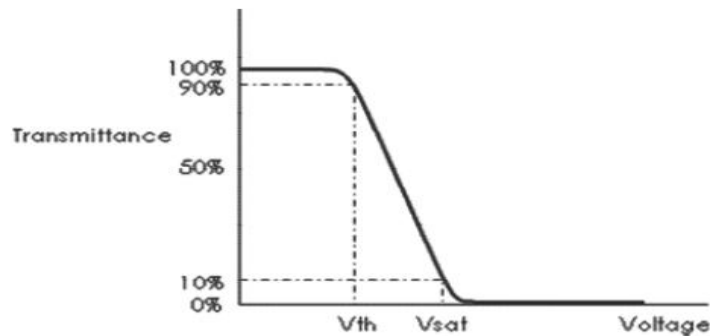

Figure 5. Measurement Set Up

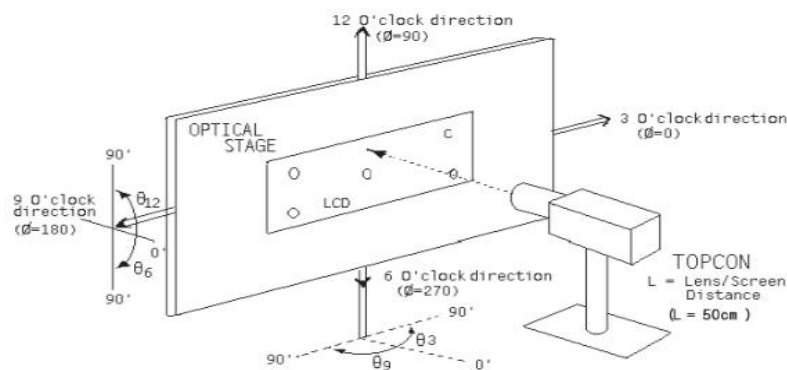
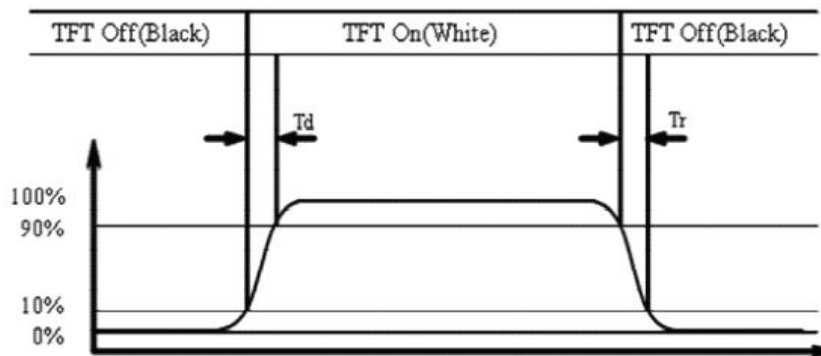

Figure 6. Response Time Testing



## 6. Timing Characteristics of Input Signals

### 6-1 Data Input Format

#### 6-1-1 6-bits LVDS Input

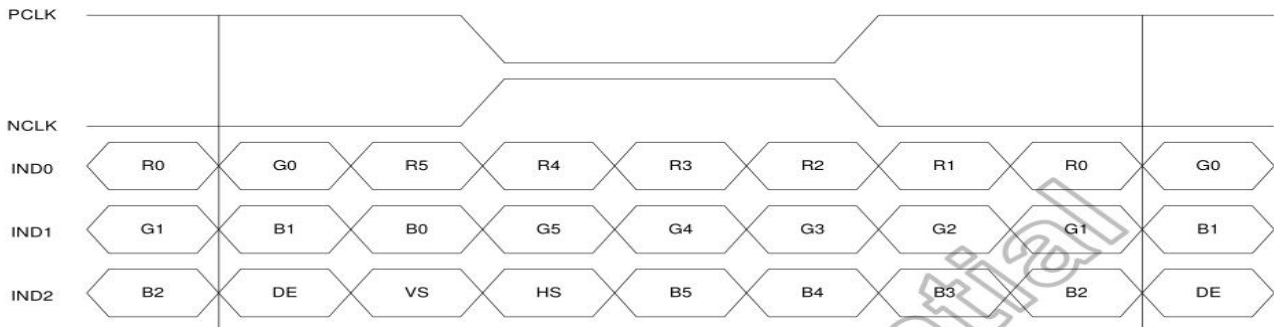

#### 6-1-2 8-bits LVDS Input

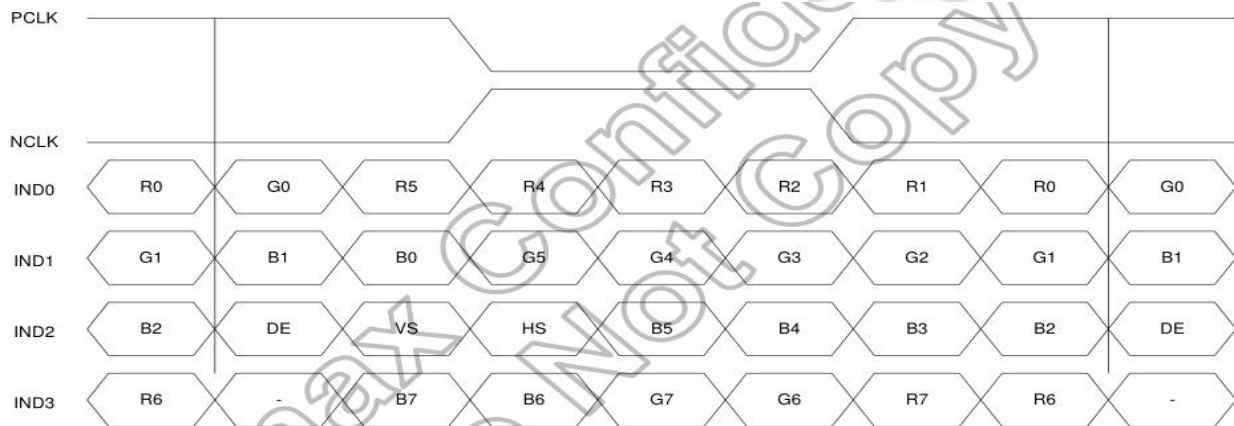

### 6-1 Timing table

Parameter	Symbol	Spec.			Unit
		Min.	Typ.	Max.	
DCLK Frequency	fclk	57	65	70.5	MHz
Horizontal Display Area	thd	1024			DCLK
HS Period	th	1200	1344	1400	DCLK
HS Pulse Width	thpw	1	-	140	DCLK
HS Back Porch	thbp	160			DCLK
HS Front Porch	thfp	16	160	216	DCLK

Parameter	Symbol	Spec.			Unit
		Min.	Typ.	Max.	
Vertical Display Area	tvd	768			$T_H$
VS Period	tv	792	806	840	$T_H$
VS Pulse Width	tvpw	1	-	20	$T_H$
VS Back Porch	tvbp	23			$T_H$
VS Front Porch	tvfp	1	15	49	$T_H$

## 7. RELIABILITY TEST

### 7-1 Temperature and Humidity

TEST ITEMS	CONDITIONS	NOTE
High Temperature Operation	70°C ; 120hrs	
High Temperature Storage	80°C ; 120hrs	
High Temperature High Humidity Operation	60°C; 90%RH ; 120hrs (No condensation)	
Low Temperature Operation	-20°C ; 120hrs	
Low Temperature Storage	-30°C ; 120hrs	
Thermal Shock	-30°C (0.5hr) ~ 80°C (0.5hr) ; 100 Cycles	Non-Operating
Image Sticking	25°C ; 2hrs	1

Note 1:

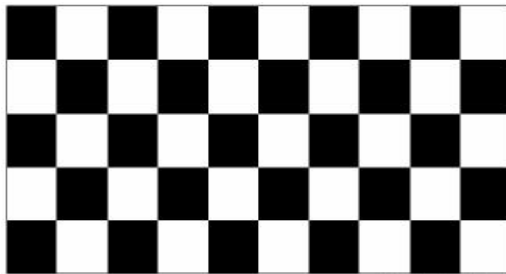

(a) Test Pattern (chess board Pattern )



(b) Gray Pattern

### 7-2 Shock and Vibration

ITEMS	CONDITIONS
Packing Shock (Non-Operation)	<ul style="list-style-type: none"> <li>● Shock level:980m/s<sup>2</sup></li> <li>● Waveform:1/2 Sine wave,6msec</li> <li>● ±X, ±Y ±Z,each axis 1 times</li> </ul>
Packing Vibration (Non-Operation)	<ul style="list-style-type: none"> <li>● Frequency range:8-33.3HZ</li> <li>● Stoke:1.0mm</li> <li>● Sweep: 10Hz-50Hz</li> <li>● x,y,z 2 hours for each direction</li> </ul>

### 7-3 Electrostatic Discharge

TEST ITEM	CONDITIONS
ESD (Non-operation)	150pF,330 Ω , Contact±4KV,Air :±8KV.Note 1
	200pF,0 Ω , ±200V Contact test.Note 2

Note:Measure Point:

- 1.LCD glass and metal bezel
- 2.IF connector pins

## 8.HANDDLING & CAUTIONS

### 8-1 Caution For Operation

◆Since the LCM is made of glass, do not apply strong mechanical impact or static load onto it. Handling with care since shock, vibration, and careless handling may seriously affect the product. If it falls from a high place or receives a strong shock, the glass maybe broken.

◆It is indispensable to drive the LCM within the specified voltage limit since the higher voltage than the limit causes LCM's life shorter. An electro-chemical reaction due to DC causes undesirable deterioration of the LCM so that the use of DC drive should avoid.

◆Do not connect or disconnect the LCM to or from the system when power is on.

◆Never use the LCM under abnormal conditions of high temperature and high humidity.

◆When expose to drastic fluctuation of temperature(hot to cold or cold to hot), the LCM may be affected; specifically, drastic temperature fluctuation from cold to hot, produces dew on the LCM's surface which may affect the operation of the polarizer on the LCM.

◆Response time will be extremely delay at lower temperature than the operating temperature range and on the other hand LCM may turn black at temperature above its operational range. However those phenomenon do not mean malfunction or out of order with the LCM. The LCM will revert to normal operation once the temperature returns to the recommended temperature range for normal operation.

◆Do not display the fixed pattern for a long time when using a normally black panel, as it may cause image sticking due to the LCM structure. If the screen is displayed in fixed mode, use a screen saver. It is recommended to display the fixed mode in less than 2 minutes or less.

◆Do not disassemble and/or re-assemble LCM module

### 8-2 Caution Against Static Charge

◆The LCM use C-MOS LSI drivers, so customers are recommended that any unused input terminal would be connected to Vdd or Vss, do not input any signals before power is turn on, and ground you body, work/assembly area, assembly equipments to protect against static electricity.

◆Remove the protective film slowly, keeping the removing direction approximate 30-degree not vertical from panel surface, if possible, under ESD control device like ion blower, and the humidity of working room should be kept over 50%RH to reduce the risk of static charge.

◆Avoid the use work clothing made of synthetic fibers. We recommend cotton clothing or other conductivity-treated fibers.

◆In handling the LCM, wear non-charged material gloves. And the conducting wrist to the earth and the conducting shoes to the earth are necessary

## 9.LCD display initialization code

**This product does not require initialization code driver**

**-END-**